

AUSTEN

256989
256991
256992

1170
1065
570
mm

1/4
Z0

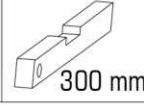
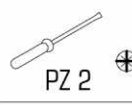
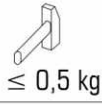

ID	ID	Dimensions	Quantity	Ratio
16546	②	522*225*16	4x	1/1
16547	③	1044*246*16	1x	1/1
16548	④	1044*246*16	1x	1/1
16549	⑤	80*522*16	1x	1/1
16550	⑥	1044*522*16	1x	1/1
16551	⑦	96*522*16	1x	1/1
16552	⑧	1170*570*16	1x	1/1
16553	⑨	1044*95*16	2x	1/1
16554	⑩	1044*80*16	2x	1/1
16555	⑪	95*522*16	1x	1/1
16556	⑫	96*522*16	1x	1/1
16557	⑬	96*860*16	2x	1/1

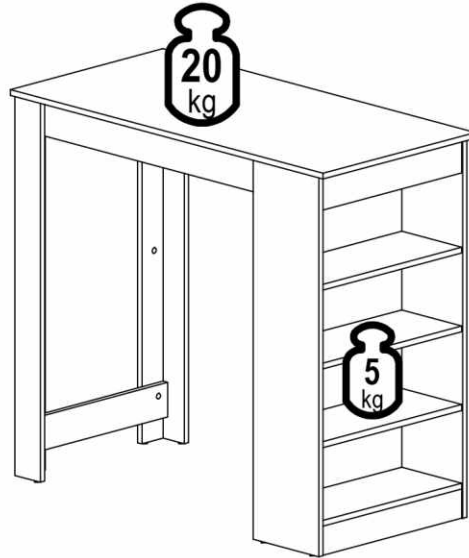

MM

150

140

130

120

110

100

90

80

70

60

50

40

30

20



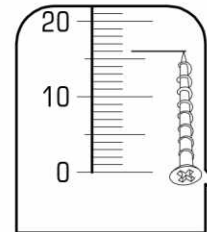
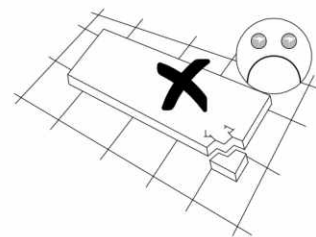
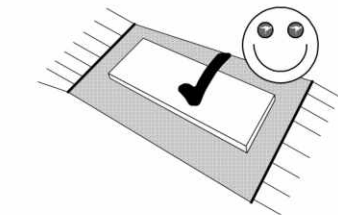
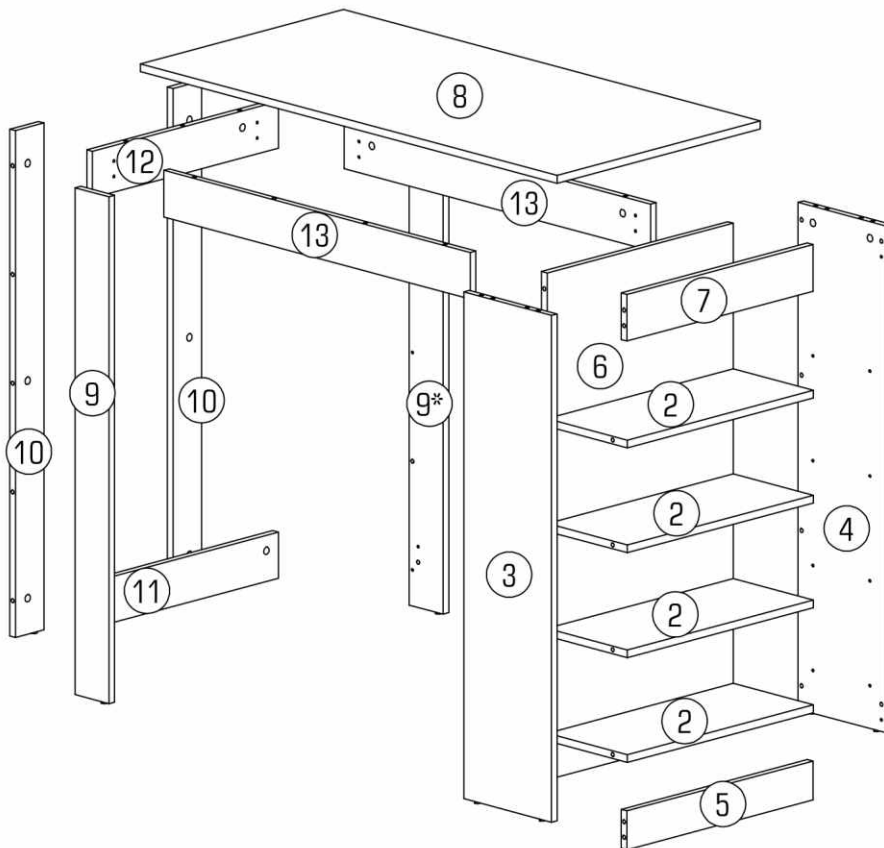

10

0

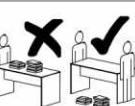
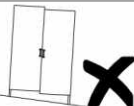





	222,43,00		24008,00		Ø 8,4		22204,00		27000,00		Ø8x30		30091,00		70013,01		Ø15x13		70021,01		31104,00	
A	4x	B	8x	C	8x	E	47x	F	8x	J	38x	K	38x	L	28x	M	2x					

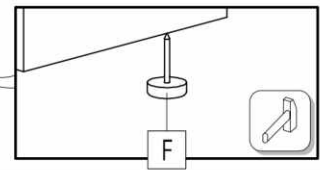
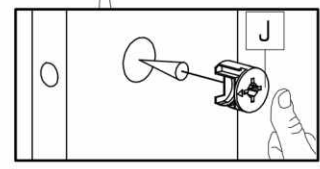
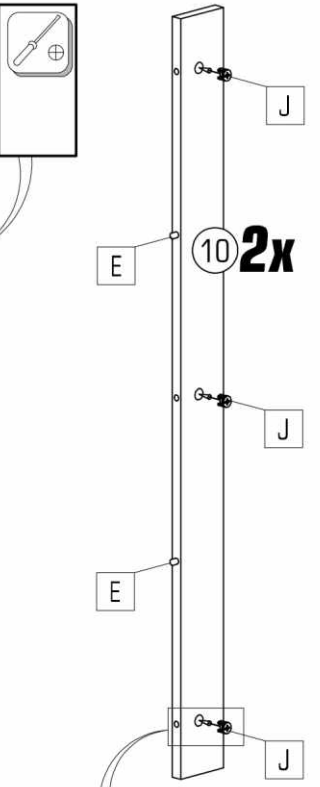
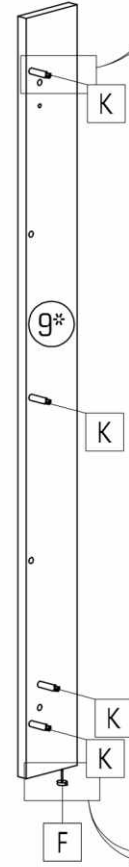
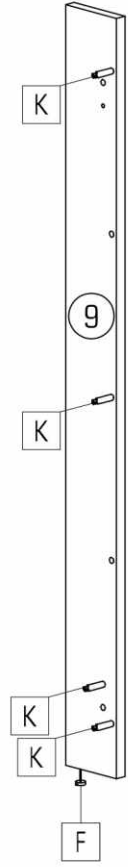
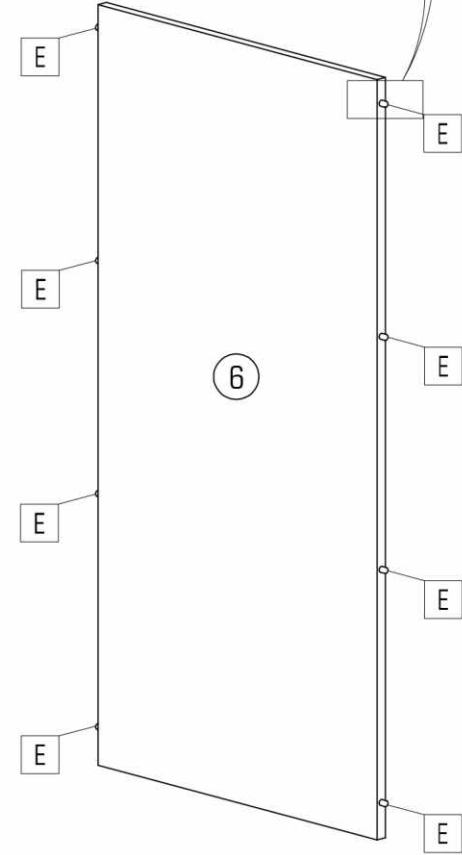
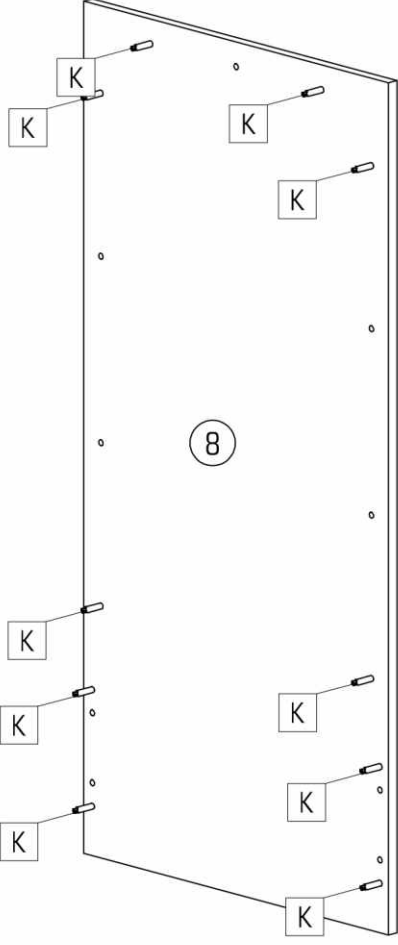
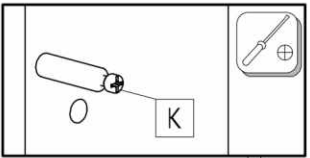
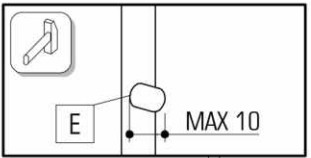



			
E 12x	F 2x	J 6x	K 18x



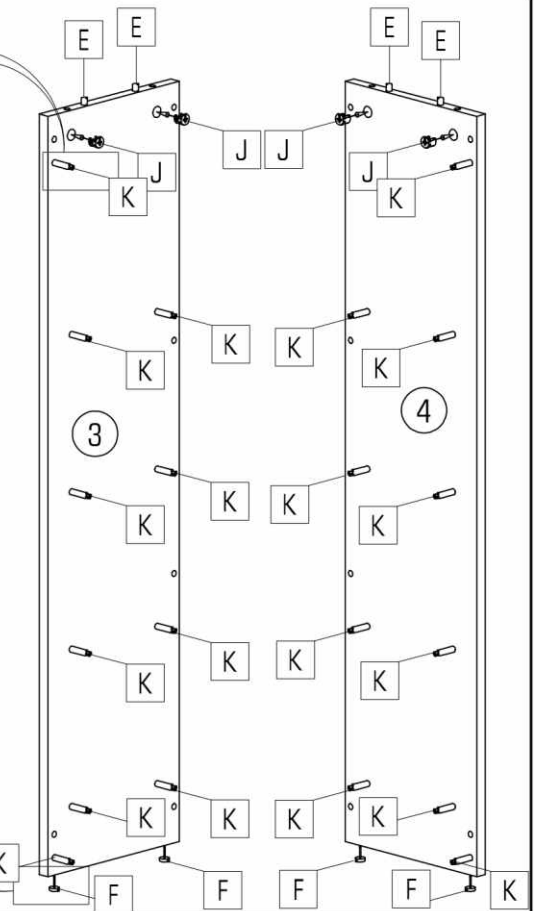
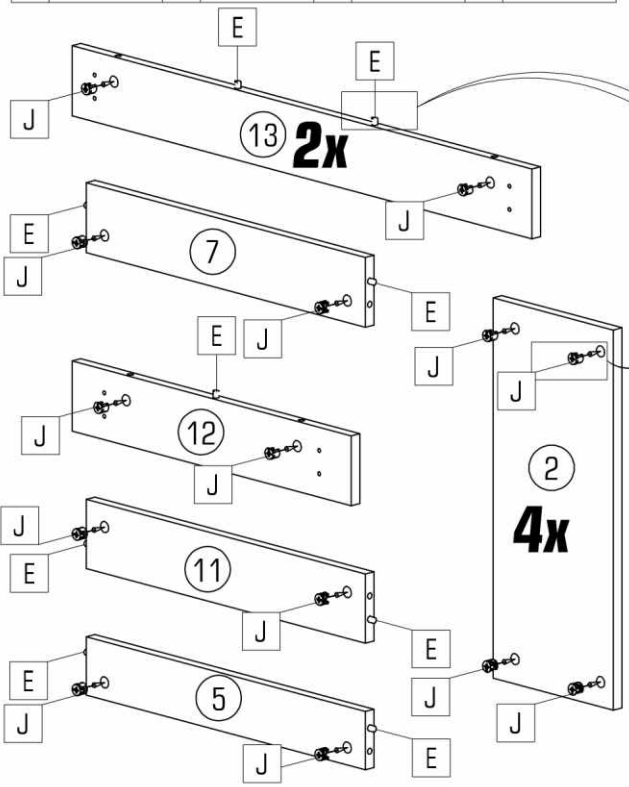
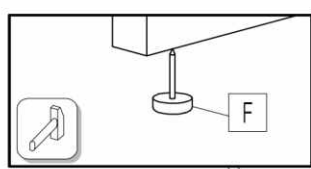
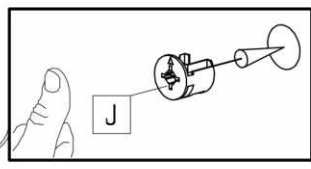
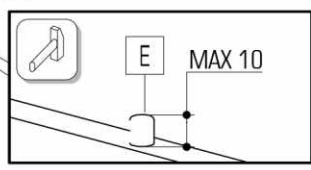
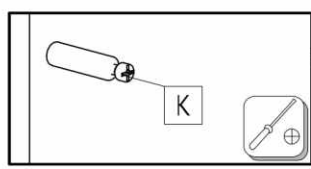

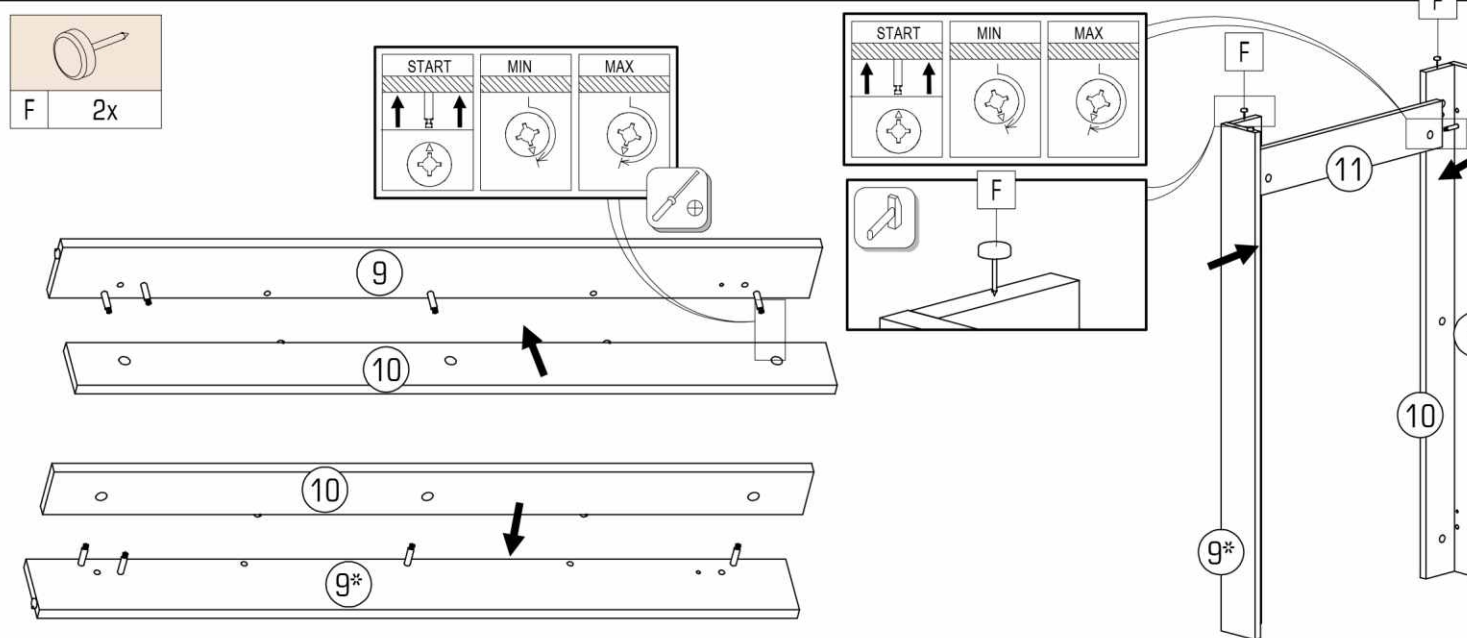
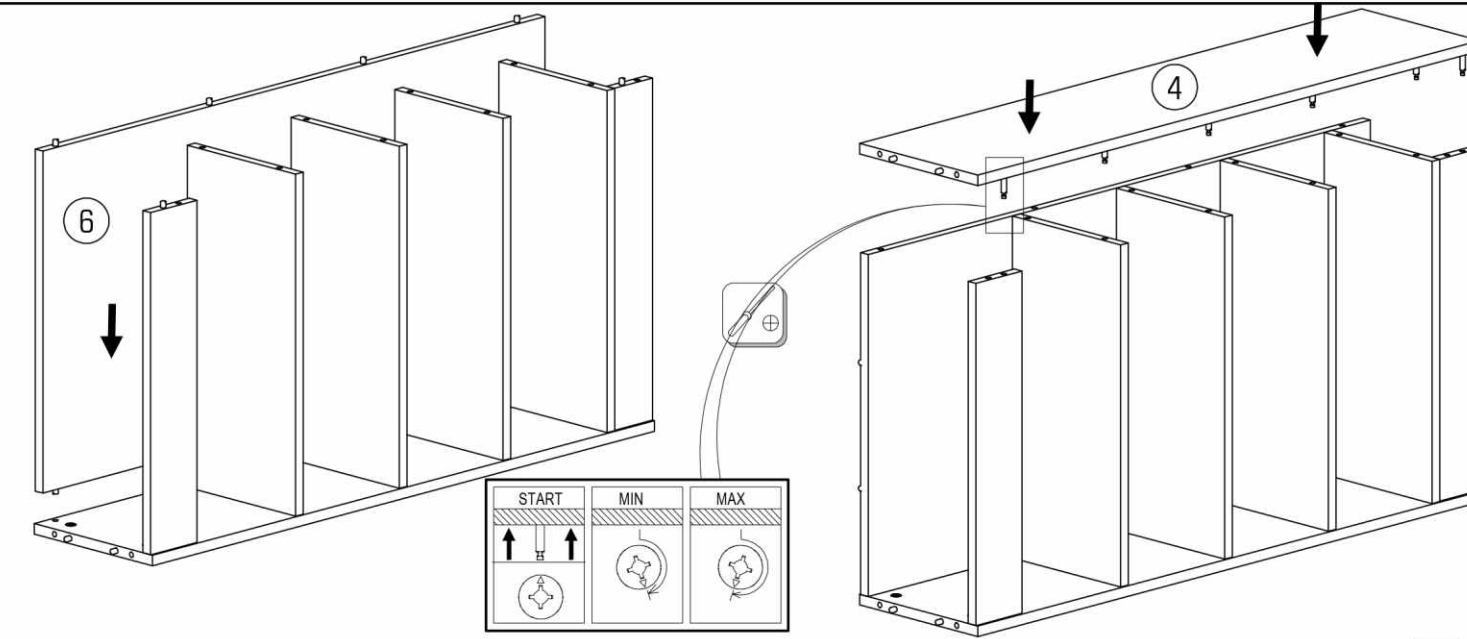
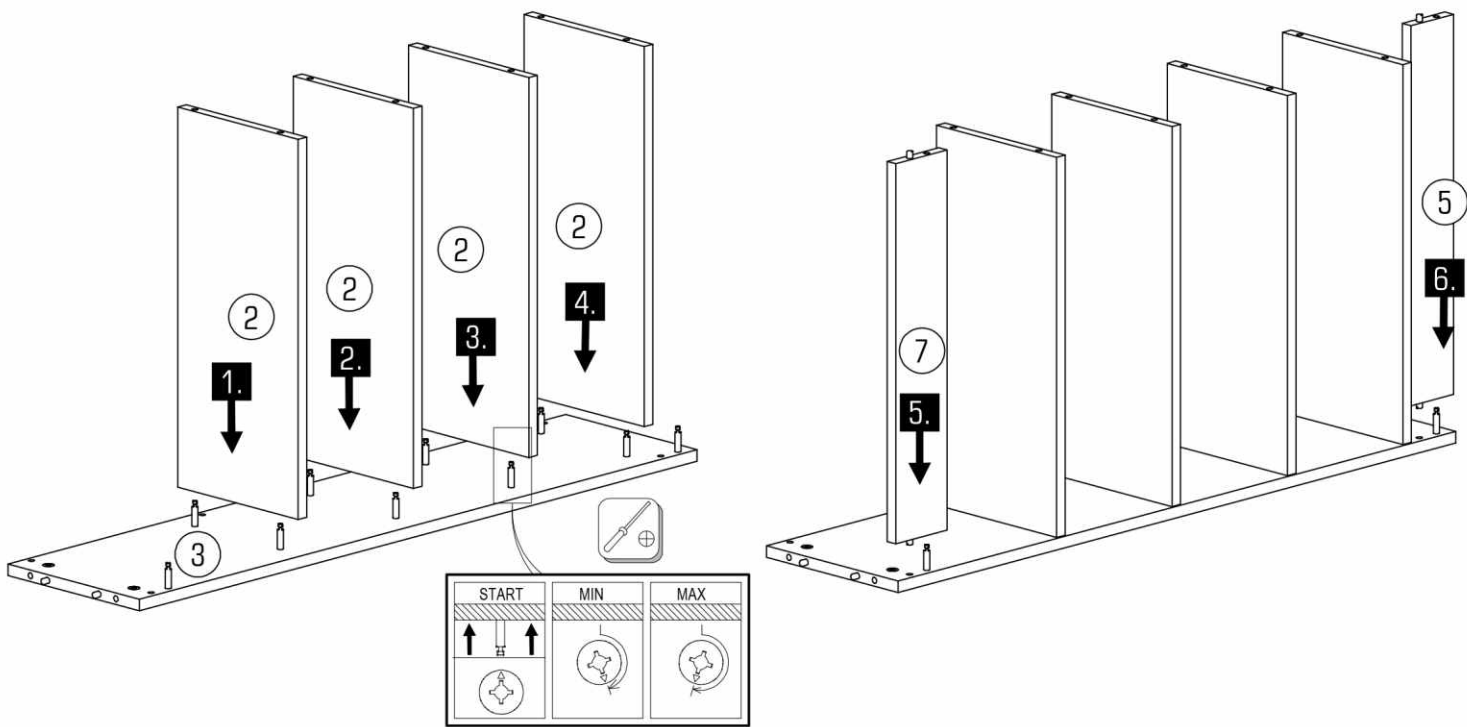
			
E 15x	F 4x	J 32x	K 20x





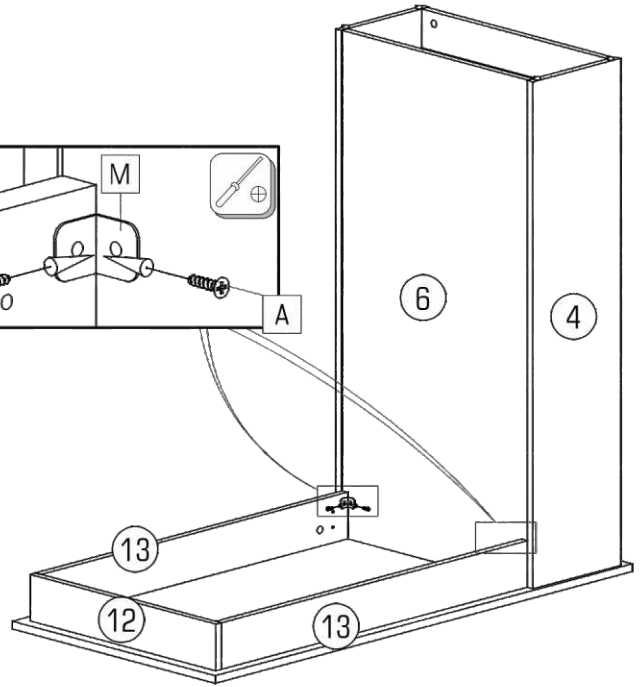
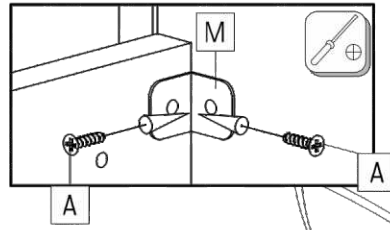
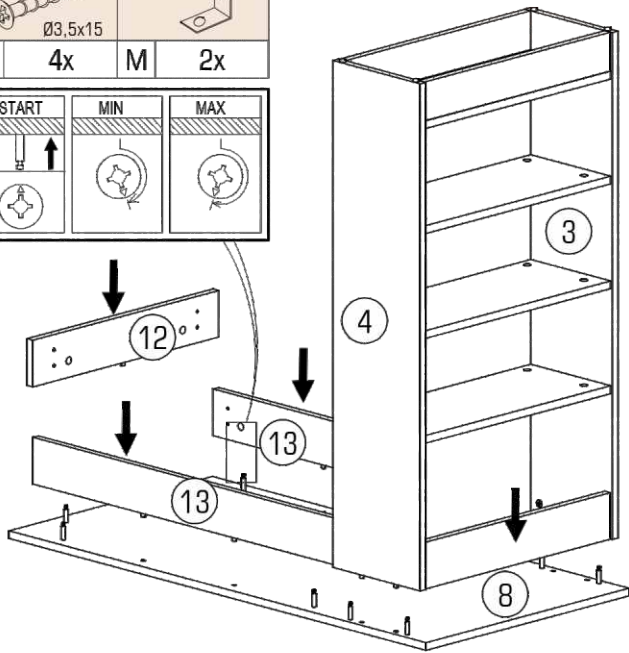

	$\varnothing 3,5 \times 15$		0
A	4x	M	2x

START	MIN	MAX
		



	$\varnothing 8,4$		$\varnothing 5,0 \times 30$		
B	8x	C	8x	L	28x

